

Article number: 439500080

Description: Rota-fix shaft-hub connection F80x120
Steel

Note: Self centering. Very high torque

Measures

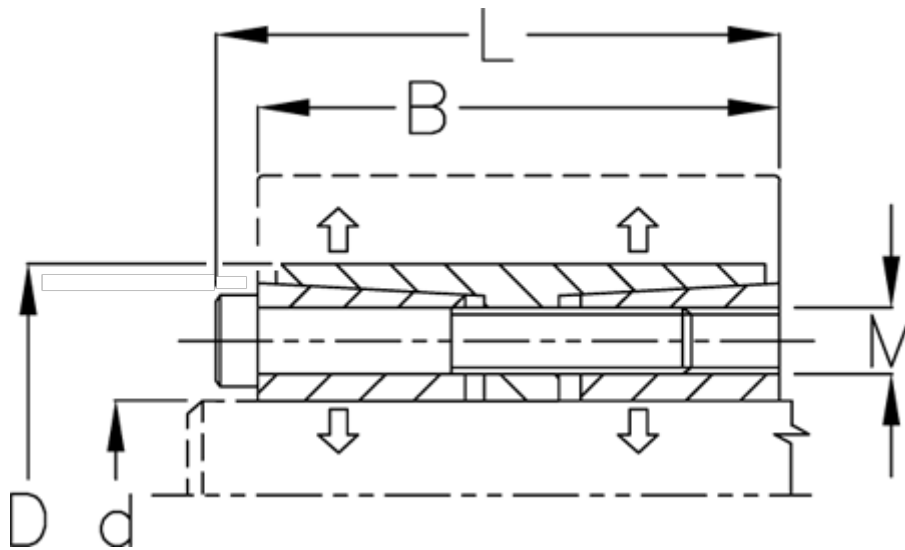

B mm	= 76
d H8 mm	= 80
D mm	= 120
Fit tolerance	= Aksel h8, Nav H8
F kN torque	= 340.0
L mm	= 86
M mm	= M10
P N/mm ² surface pressure on shaft/hub	= 110

Surface roughness	= R? ? 3.2 µm
T N m torque	= 14000
Ts N m bolt tightening torque	= 83.0